

VC-BC601P
HD Camera
(FHD Box Camera)

User Manual - English



[Important]

To download the latest version of Quick Start Guide, multilingual user manual, software, or driver, etc., please visit Lumens

<https://www.MyLumens.com/support>

Table of Contents

Copyright Information	2
Chapter 1 Safety Instructions	3
Chapter 2 Package Contents.....	5
Chapter 3 Function Introduction.....	6
3.1 I/O functions Introduction	6
3.2 Tally Indicator Light Function Description	7
Chapter 4 Instruction for installation.....	8
4.1 Basic Devices.....	8
4.2 Connecting devices.....	9
Chapter 5 Network Function Settings Description	11
5.1 Web System Requirements	11
5.2 Connecting Camera to Network	11
5.3 Web Page Function Description.....	15
Chapter 6 Troubleshooting	31

Copyright Information

Copyrights © Lumens Digital Optics Inc. All rights reserved.

Lumens is a trademark that is currently being registered by Lumens Digital Optics Inc.

Copying, reproducing or transmitting this file is not allowed if a license is not provided by Lumens Digital Optics Inc. unless copying this file is for the purpose of backup after purchasing this product.

In order to keep improving the product, Lumens Digital Optics Inc. hereby reserves the right to make changes to product specifications without prior notice. The information in this file is subject to change without prior notice.

To fully explain or describe how this product should be used, this manual may refer to names of other products or companies without any intention of infringement.

Disclaimer of warranties: Lumens Digital Optics Inc. is neither responsible for any possible technological, editorial errors or omissions, nor responsible for any incidental or related damages arising from providing this file, using, or operating this product.

Chapter 1 Safety Instructions

Always follow these safety instructions when setting up and using the product:

1 Operation

- 1.1 Please use the product in the recommended operating environment.
- 1.2 Do not place the product in tilted position.
- 1.3 Do not place the product on an unstable trolley, stand or table.
- 1.4 Do not use the product near water or source of heat.
- 1.5 Use attachments only as recommended.
- 1.6 Use the type of power source indicated on the product. If you are not sure of the type of power available, consult your distributor or local electricity company for advice.
- 1.7 Always take the following precautions when handling the plug. Failure to do so may result in sparks or fire:
 - Ensure the plug is free of dust before inserting it into a socket.
 - Ensure that the plug is inserted into the socket securely.
- 1.8 Do not overload wall sockets, extension cords or multi-way plug boards to avoid potential risks.
- 1.9 Do not block the slots and openings in the case of the product. They provide ventilation and prevent the product from overheating.
- 1.10 Except as specifically instructed in this User Manual, do not open or remove covers, otherwise it may expose you to dangerous voltages and other hazards. Refer all servicing to licensed service personnel.
- 1.11 Unplug the product from the wall outlet and refer servicing to licensed service personnel when the following situations happen:
 - If the power cords are damaged or frayed.
 - If liquid is spilled into the product or the product has been exposed to rain or water.

2 Installation

- 2.1 For security considerations, please make sure the standard hanging rack you bought is in line with UL or CE safety approbations and installed by technician personnel approved by agents.

3 Storage

- 3.1 Do not place the product where the cord can be stepped on as this may result in fraying or damage to the lead or the plug.
- 3.2 Never push objects of any kind through cabinet slots. Never allow liquid of any kind to spill into the product.
- 3.3 Unplug this product during thunderstorms or if it is not going to be used for an extended period.
- 3.4 Do not place this product or accessories on top of vibrating equipment or heated objects.

4 Cleaning

- 4.1 Unplug all the cables before cleaning. Use a damp cloth for cleaning. Do not use liquid or aerosol cleaners.





5 Remote control (if the accessories are equipped with remote control)

- 5.1 Using an incorrect battery type in the remote control may result in breakdown. Follow local instructions on how to dispose of used batteries.

■ Precautions

Warning: To reduce the risk of fire or electric shock, do not expose this appliance to rain or moisture.

If the HD camera will not be used for an extended time, unplug it from the power socket.

	Caution Risk of Electric Shock Please do not open it by yourself	
Caution: To reduce the risk of electric shock, do not remove cover (or back). No user-serviceable parts inside. Refer servicing to licensed service personnel.		
	This symbol indicates that this equipment may contain dangerous voltage which could cause electric shock.	
		This symbol indicates that there are important operating and maintenance instructions in this User Manual with this unit.

■ **FCC Warning**

This HD Camera has been tested and found to comply with the limits for a Class A digital device, pursuant to Article 15-J of FCC Rules. These limits are designed to provide reasonable protection against harmful interference in a commercial installation.

This digital apparatus does not exceed the Class A limits for radio noise emissions from digital apparatus as set out in the interference-causing equipment standard entitled "Digital Apparatus," ICES-003 of Industry Canada.

Cet appareil numérique respecte les limites de bruits radioélectriques applicables aux appareils numériques de Classe A prescrites dans la norme sur le matériel brouilleur: "Appareils Numériques," NMB-003 édictée par l'Industrie.

■ **EN55032 (CE Radiation) Warning**

Operation of this equipment in a residential environment could cause radio interference.

Chapter 2 Package Contents

VC-BC601P



Power Cord

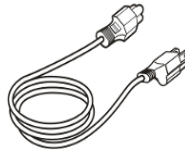

Appearance may vary
depending on country/region

Power Adapter

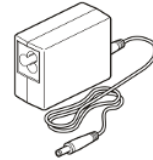

Chapter 3 Function Introduction

3.1 I/O functions Introduction



NO.	Item	Function Descriptions
1	Lens	30x HD camera lens
2	Tally indicator light	Display the tally light status of the camera
3	Network port	Network port, support routers or hubs (IEEE 802.3 af) with PoE power supply support
4	3G-SDI output	The factory setting for the output resolution is 1080P/60
5	Power indicator light	After power is on, the indicator light will display in red
6	DC 12 V power connector	AC power supply connecting port
7	RS232 output	RS232 output port, at most 7 cameras can be connected in a serial connection
8	RS232 input	RS232 input port, at most 7 cameras can be connected in a serial connection
9	HDMI output	HDMI output
10	Audio input	Support Line In/Mic In
11	Audio output	Support 3.5 mm audio input
12	Tripod screw holes	The camera is mounted on a (specification) 1/4", 20 UNC tripod deck or installed on VC-WM11 (optional)

3.2 Tally Indicator Light Function Description

The Tally lamp function may be enabled through the RS232 command. Please refer to [RS-232 command set](#) document

Chapter 4 Instruction for installation

4.1 Basic Devices

4.1.1 VC-BC601P size

Length x Width x Height : 186.71 x 67.0 x 67.0 mm

Weight : 1 Kg

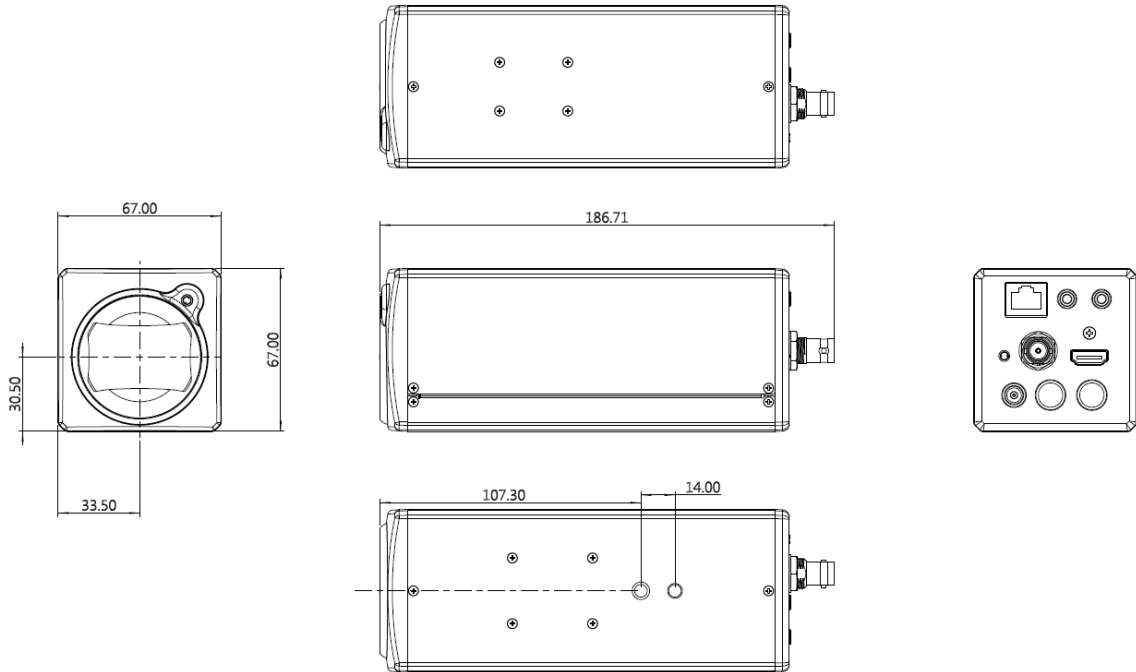

4.1.2 Installation method

4.1.2.1 Wall-mounted frame: The camera is installed on the wall, using Lumens VC-WM11 (optional) wall-mounted frame

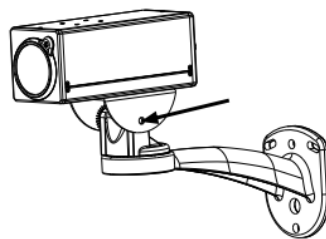

4.1.2.2 Tripod: The camera is mounted on a 1/4", 20 UNC PTZ tripod deck



4.2 Connecting devices

4.2.1 Using HDMI/3G-SDI connect to the screen

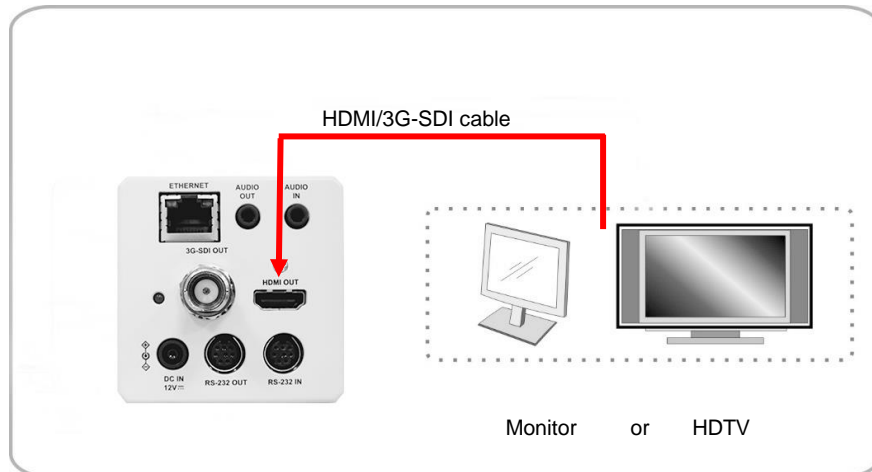

4.2.2 Connecting to Internet

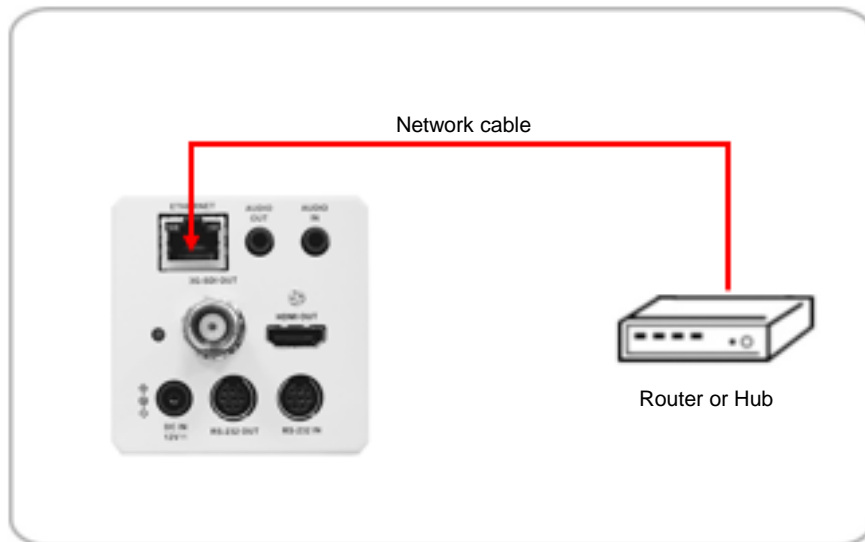

<Remark> For details of web page connection setting and description, please refer to [Chapter 5 Network Function Settings Description](#).

4.2.3 Connecting AUDIO IN

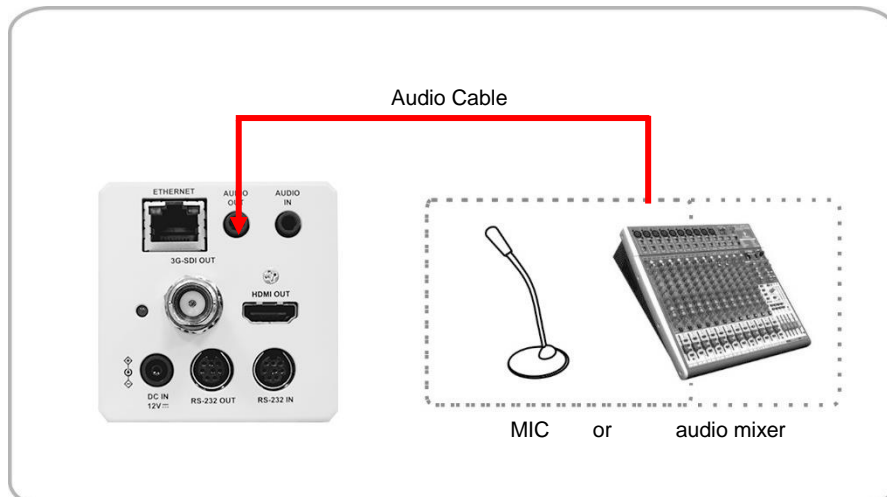

4.2.4 Connecting RS-232

■ RS-232 serial connection

With RS-232 in/out, at most 7 Lumens cameras can be connected.

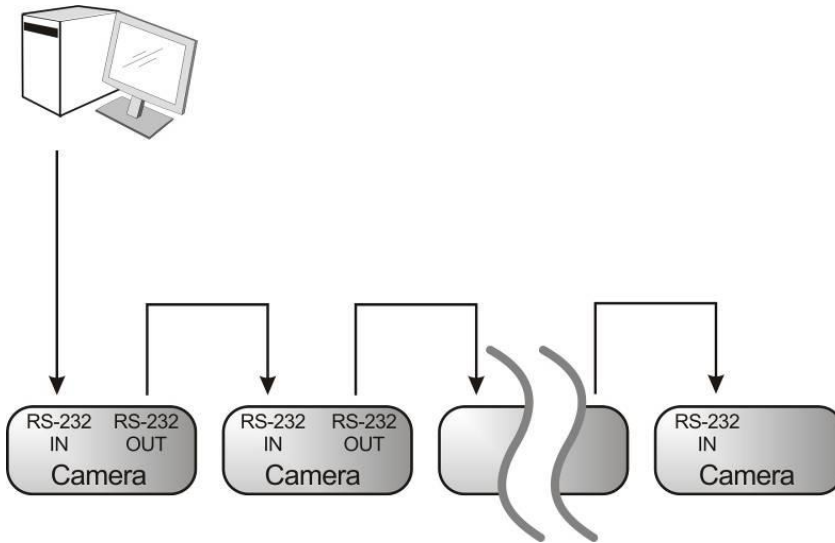

■ RS-232 pin definition description

▼ RS-232 IN Pins Instructions

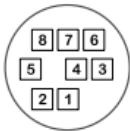

NO	Pins	Signals
1	DTR	Data Transmission Reade
2	DSR	Data Set Reade
3	TXD	Transmit Data
4	GND	Ground
5	RXD	Receive Data
6	GND	Ground
7	IR OUT	IR Commander Signal
8	N.C.	No Connection

▼ RS-232 OUT Pins Instructions

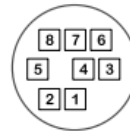

NO	Pins	Signals
1	DTR	Data Transmission Reade
2	DSR	Data Set Reade
3	TXD	Transmit Data
4	GND	Ground
5	RXD	Receive Data
6	GND	Ground
7	OPEN	Reserved
8	OPEN	Reserved

▼ RS-232 Connection Instructions

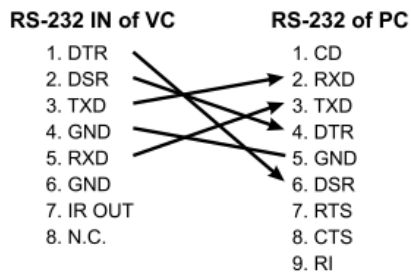

▼ RS-232 Connection Instructions

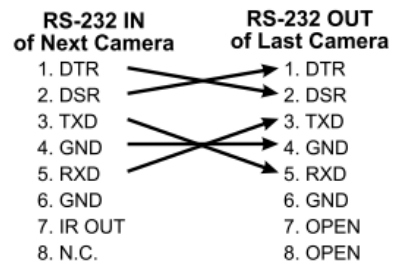

Chapter 5 Network Function Settings Description

5.1 Web System Requirements

5.1.1 Web Browser:

- Internet Explorer 11 or above
- FireFox 66.0.3 or above
- Chrome 73 or above
- Edge 42.17134 or above
- Safari 12.1 or above

5.2 Connecting Camera to Network

5.2.1 Connecting to Internet

Two common connection methods are shown below

1. Connecting via switch or router

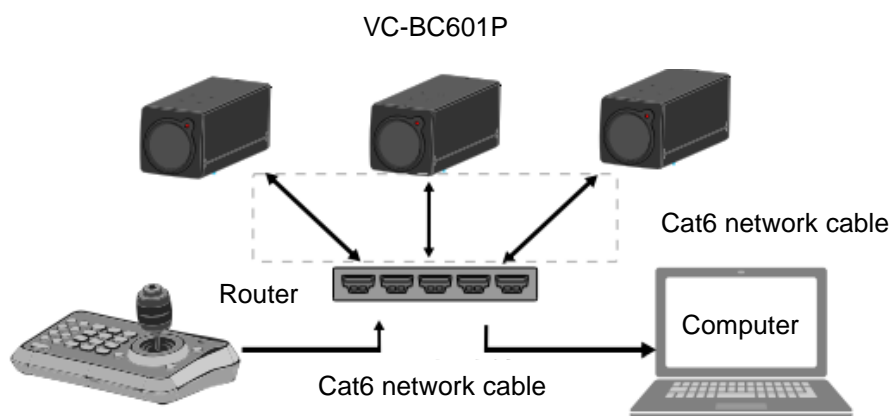

2. To connect directly through network cable, the IP address of the computer should be changed so that it is on the same network segment as the camera
e.g.: The factory-preset default IP address of VC-BC601P is 192.168.100.100. The computer IP address must be set with the same network segment, such as 192.168.100.101, so that the computer can be connected correctly with the camera

- Connection diagram

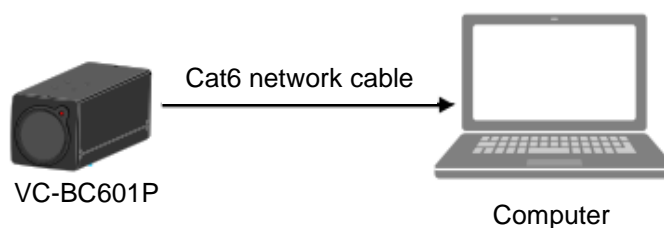

- Change network settings

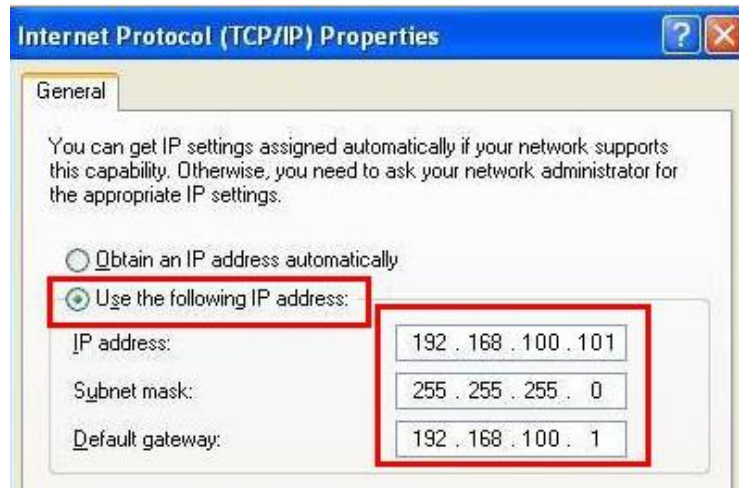

5.2.2 Using Lumens VMS Software to View the Images

- The VC-BC601P DHCP initial setting is ON. If VC-BC601P is connected to the local area network (LAN), the camera IP can be retrieved via the following methods
 - Install Lumens VMS software (Please download from the Lumens official website, <http://www.mylumens.com/support>)
 - Open **LUMENS VMS** software
 - Search for the camera: Press  [automatically search for the device] button to locate the VC-BC601P camera
 - Click VC-BC601P in the list and start operation after connecting to network
- <Note> When using automatic search, the camera and computer must be in the same network segment, e.g.: 192.168.4.X**

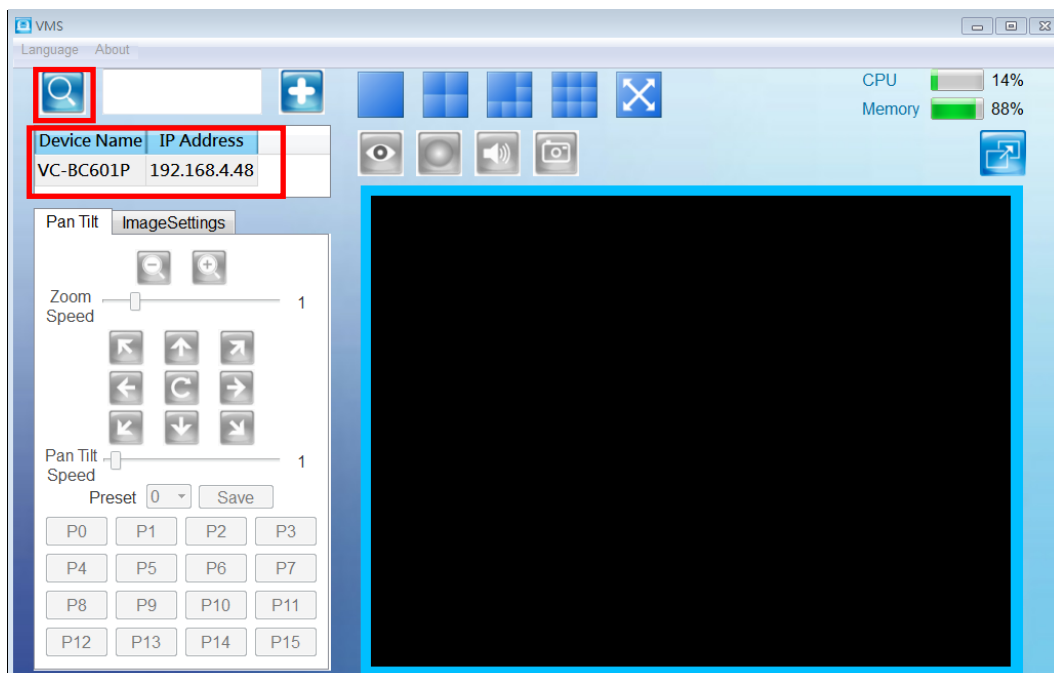

5.2.3 Using the Browser to View the Images

- Open the browser, and enter the URL of VC-BC601P in the IP address bar
e.g.: <http://192.168.100.100> (default IP address)
- Enter administrator's account and password
Account: admin (Default)
Password: 9999 (Default)



5.2.4 Using RTSP Player to View the Images

In addition to the browser and VMS, other free softwares also can be used for RTSP connection, such as VLC, Quick Time and PotPlayer

RTSP connection address formats are as follows:

- RTSP Main Streaming (1080P@H.265) => <rtsp://camera IP:8554/hevc>
- RTSP Sub1 Streaming (1080P@H.264) => <rtsp://camera IP:8557/h264>
- RTSP Sub2 Streaming (720P@H.264) => <rtsp://camera IP:8556/h264>

If password authentication is enabled, the RTSP connection address is as follows:

- [RTSP Main Streaming](#)
<rtsp://Username:Password@VC IP address:port/hevc>
- RTSP Sub1/ Sub2 Streaming
<rtsp://Username:Password@VC IP address:port/h264>
- To enable password authentication function, please refer to [5.3.9 Setting-Network](#)

Example: Open VLC software and enter URL: <rtsp://192.168.4.48:8557/h264>

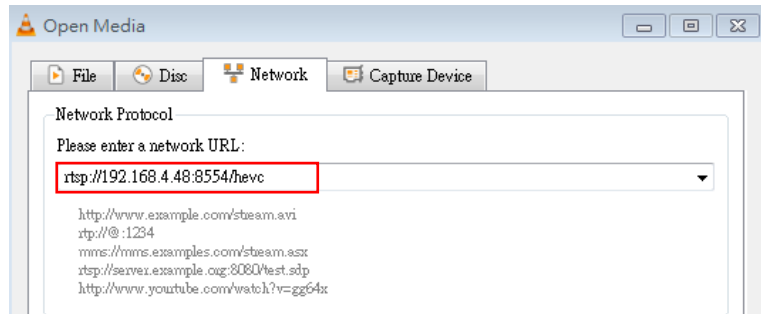
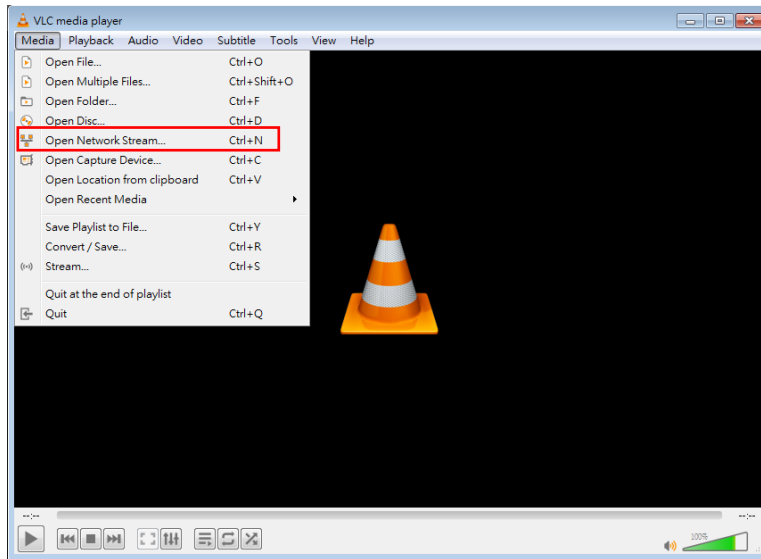

5.3 Web Page Function Description

5.3.1 Login Screen

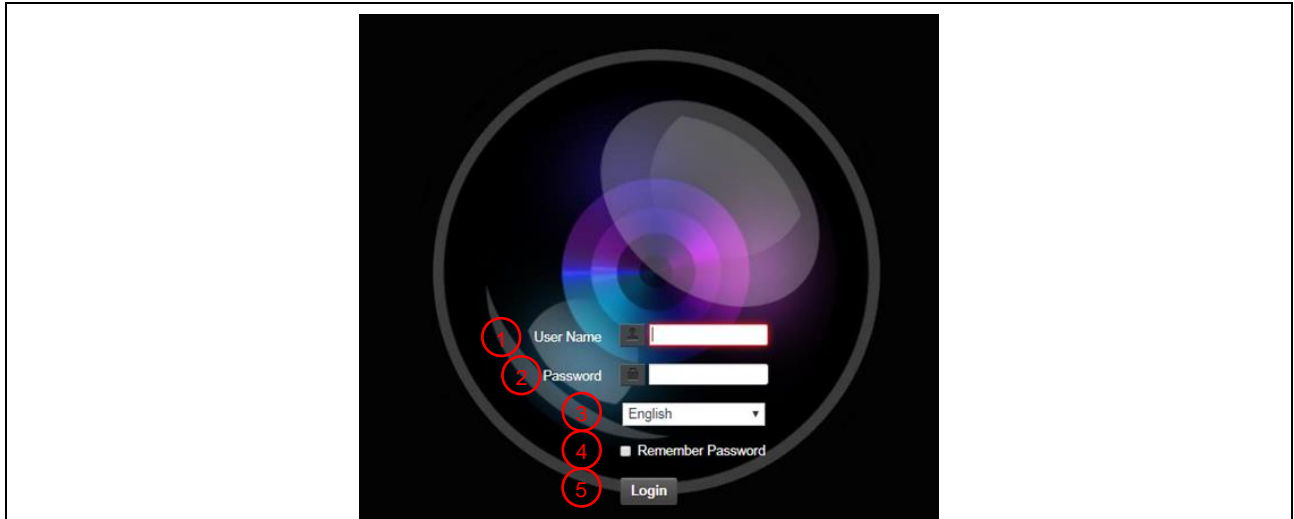

No	Item	Function Descriptions
1	Username	Enter user account (default: admin)
2	Password	Enter user password (default: 9999)
3	Language selection	Currently, the system supports English, Traditional Chinese and Simplified Chinese
4	Remember password	Save user account name and password to the browser. When you log in next time, there is no need to re-enter them
5	Login	Log into the administrator screen on the website

5.3.2 Viewing In Real Time

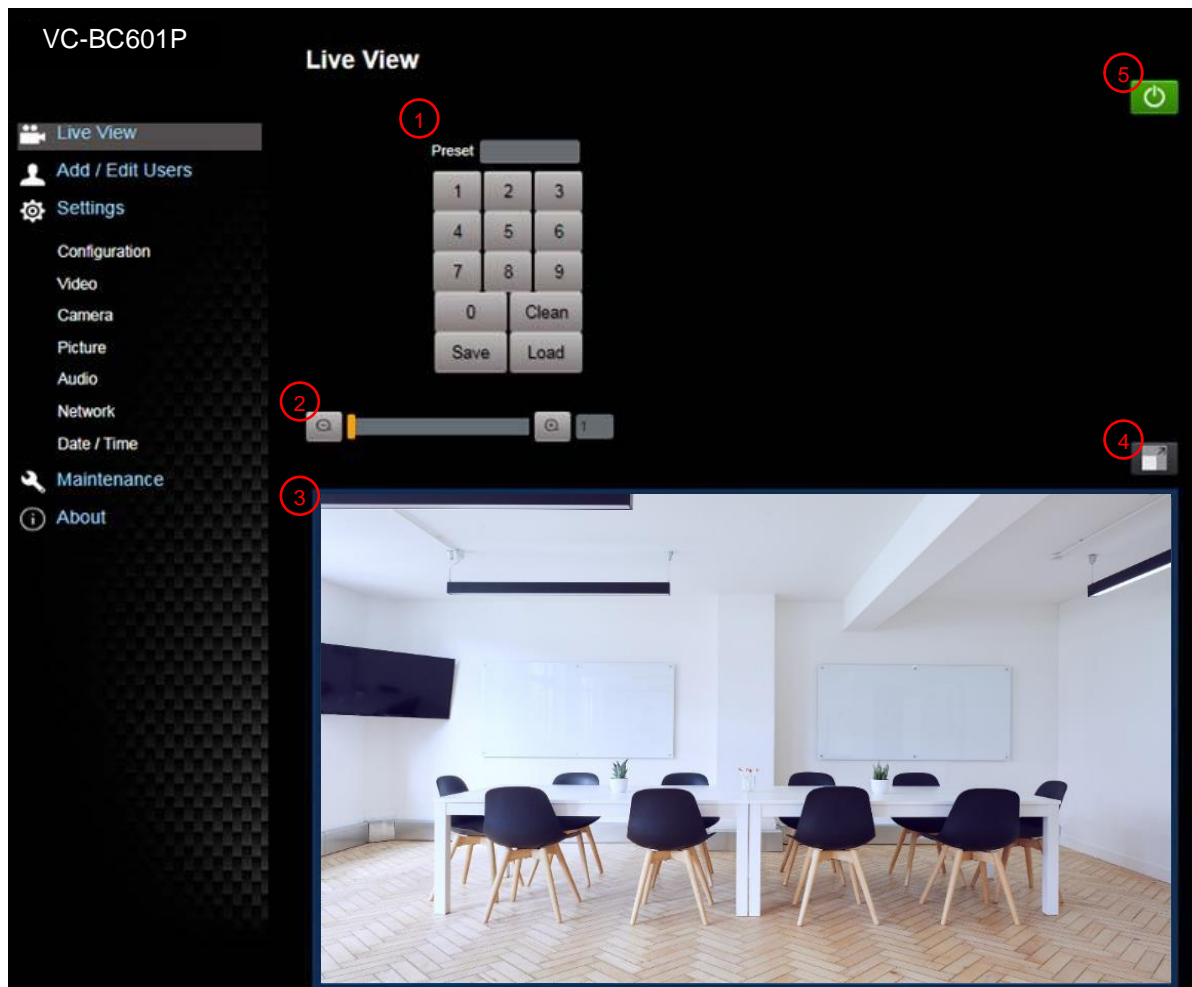

No	Item	Function Descriptions
1	Preset setting	Select the number first and then select SAVE or LOAD
2	Zoom ratio	Adjust the zoom-in or zoom-out ratio via scroll bar
3	Preview window	Display the screen currently captured by the camera
4	Switch to Full Screen	Switch the preview window to full screen
5	Power button	Turn on or turn off the camera power

5.3.3 Account Management

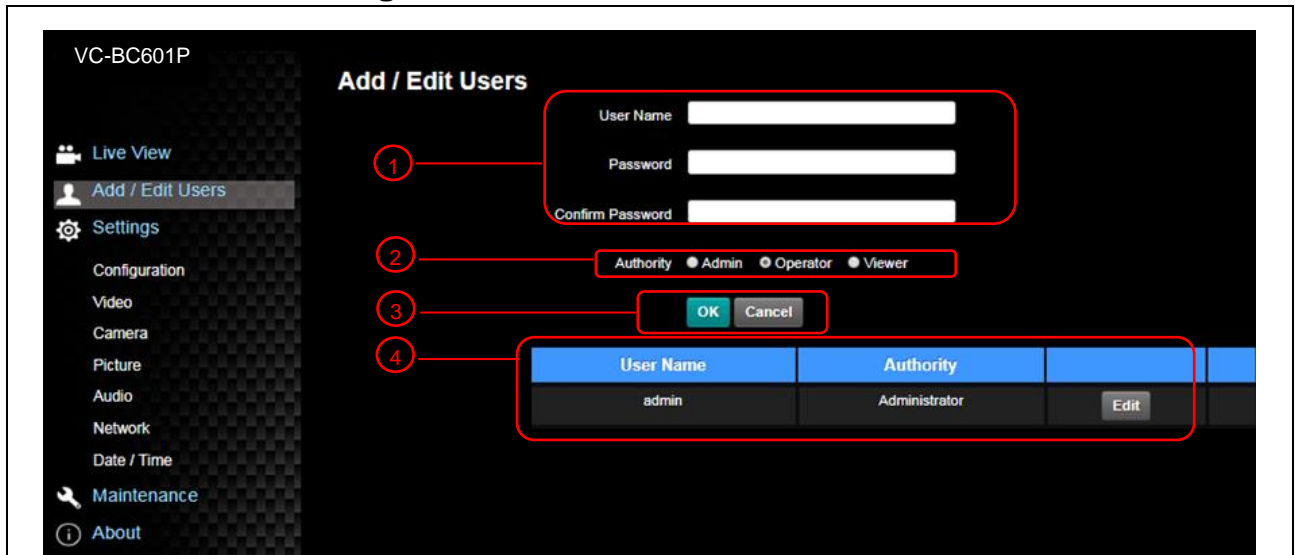

No	Item	Function Descriptions																
1	Add user account	Enter a user name and password to add a new user																
2	Permission setting	Set the new account management permissions <table border="1" data-bbox="603 907 1337 1104"> <thead> <tr> <th>User Type</th> <th>Admin</th> <th>Operator</th> <th>Viewer</th> </tr> </thead> <tbody> <tr> <td>View images</td> <td>Y</td> <td>Y</td> <td>Y</td> </tr> <tr> <td>Settings</td> <td>Y</td> <td>Y</td> <td>N</td> </tr> <tr> <td>Account management</td> <td>Y</td> <td>N</td> <td>N</td> </tr> </tbody> </table>	User Type	Admin	Operator	Viewer	View images	Y	Y	Y	Settings	Y	Y	N	Account management	Y	N	N
User Type	Admin	Operator	Viewer															
View images	Y	Y	Y															
Settings	Y	Y	N															
Account management	Y	N	N															
3	Applying setting	Add the newly created user to the list of accounts																
4	List of accounts	Edit: Modify the user password and permissions Delete: Delete the user account																

5.3.4 Setting - System Setting

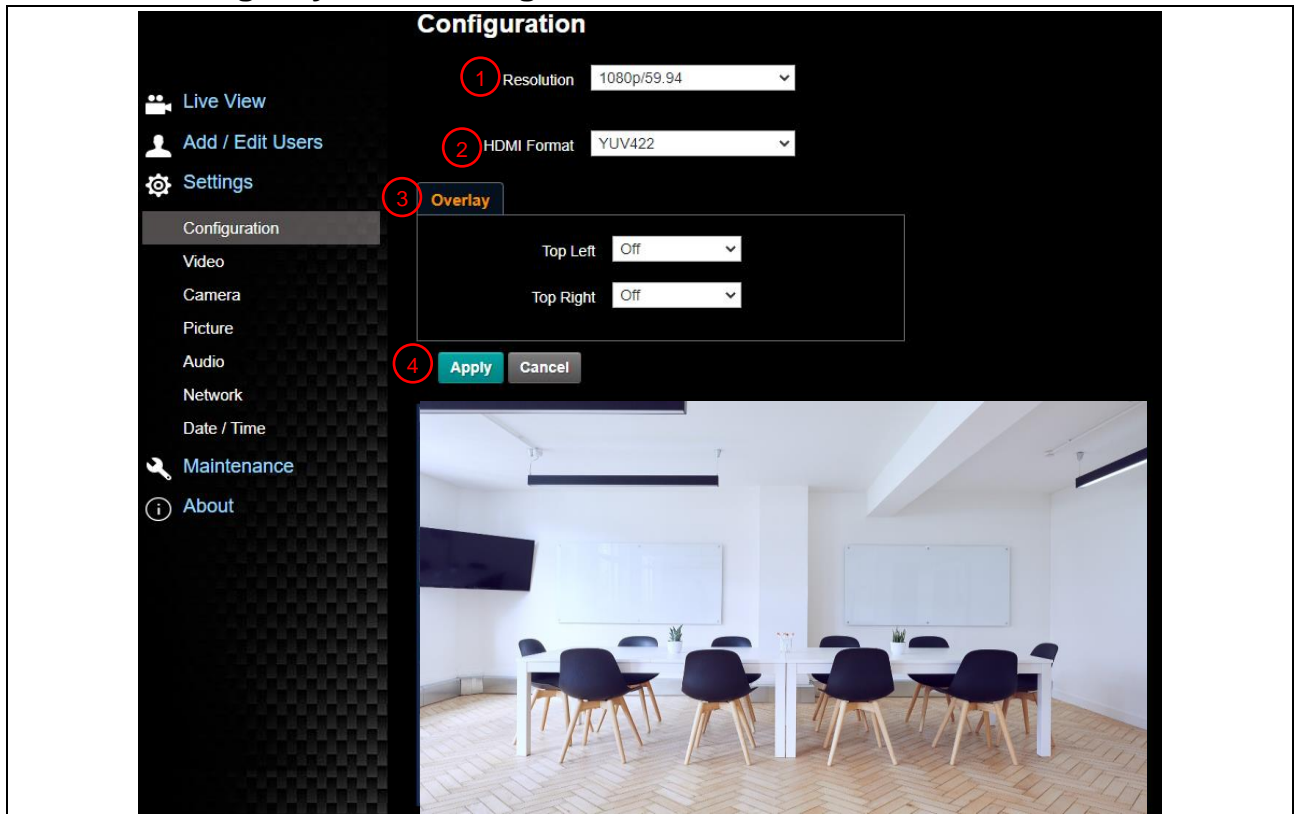

No	Item	Function Descriptions
1	Resolution	<p>Set the resolution of the camera, resolutions supported by the camera are as follows:</p> <ul style="list-style-type: none"> ➤ 1080p/59.94 ➤ 1080p/50 ➤ 1080p/29.97 ➤ 1080p/25 ➤ 720p/59.94 ➤ 720p/50 ➤ 720p/29.97 ➤ 720p/25 <p>After switching the resolution, the camera will restart. If there are no images on the website, please refresh the browser</p>
2	Apply	After the setting has been modified, select this button to apply the setting
3	Overlay	Set the stream to display “date and time” or “customized content” and to display “location”
4	Apply	After the setting has been modified, select this button to apply the setting

5.3.5 Setting - Video

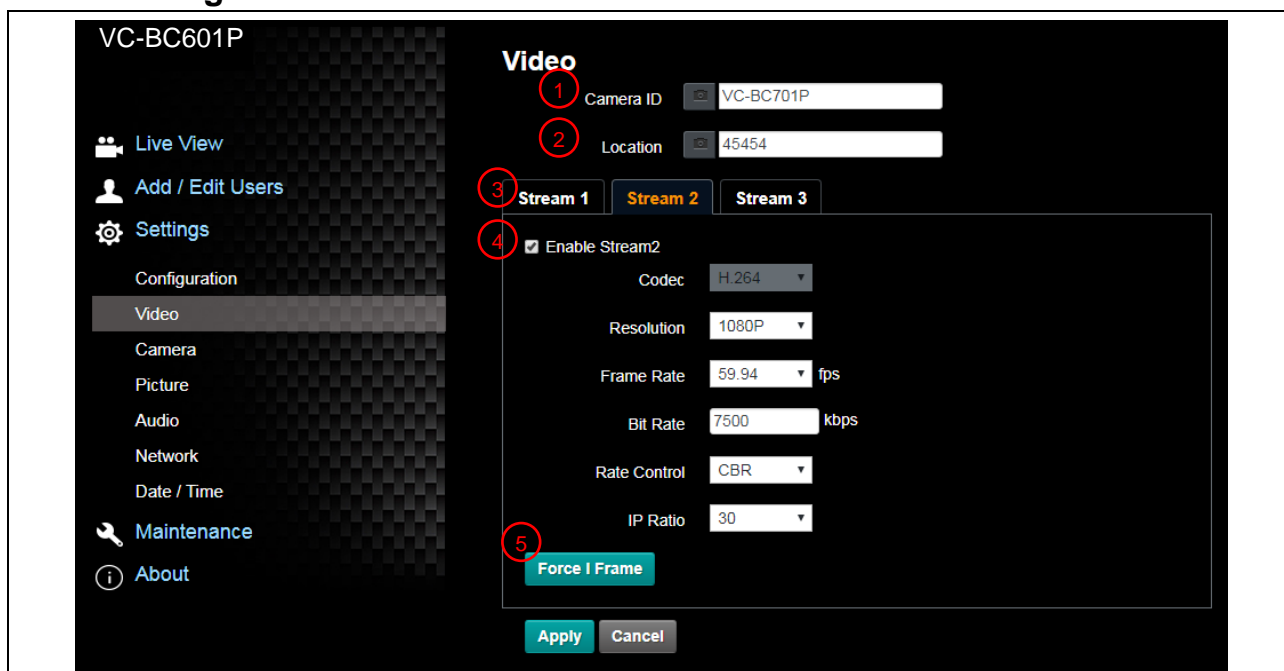



No	Item	Function Descriptions
1	Camera name	Modify the camera name <ul style="list-style-type: none"> Camera names are limited to 1 - 12 characters Please use a camera name by mixing uppercase and lowercase letters or numbers. Do not use "/" and "space" or special symbols
2	Camera Location	Modify the location of the camera, such as Meeting Room 1 <ul style="list-style-type: none"> Camera location is limited to 1 - 12 characters Please use a camera location by mixing uppercase and lowercase letters or numbers. Do not use "/" and "space" or special symbols
3	Streaming 1/Streaming 2/Streaming 3	VC-BC601P supports 3 streaming outputs. Please refer to 5.3.5.1 Streaming Parameter Setting for relevant settings
4	Enable Streaming	Confirm whether or not the streaming function is opened
5	Force I Frame	Check this item to insert IDR frame into specified series flow and apply its setting. User's setting will be reserved and displayed in GUI interface

5.3.5.1 Streaming parameter setting

Function		Streaming 1	Streaming 2	Streaming 3
Encode Format		H.265	H.264	
Resolution		1080P/720P		640 x 360
Frame Rate		Setting according to the supported resolution		
Bit Rate (kbps)	Range	2,000 ~ 20,000	2,000 ~ 20,000	512 ~ 5,000
	Factory Default	7,000	7,000	1,000
Rate Control		CBR/VBR		
IP Ratio		Setting according to the supported resolution		

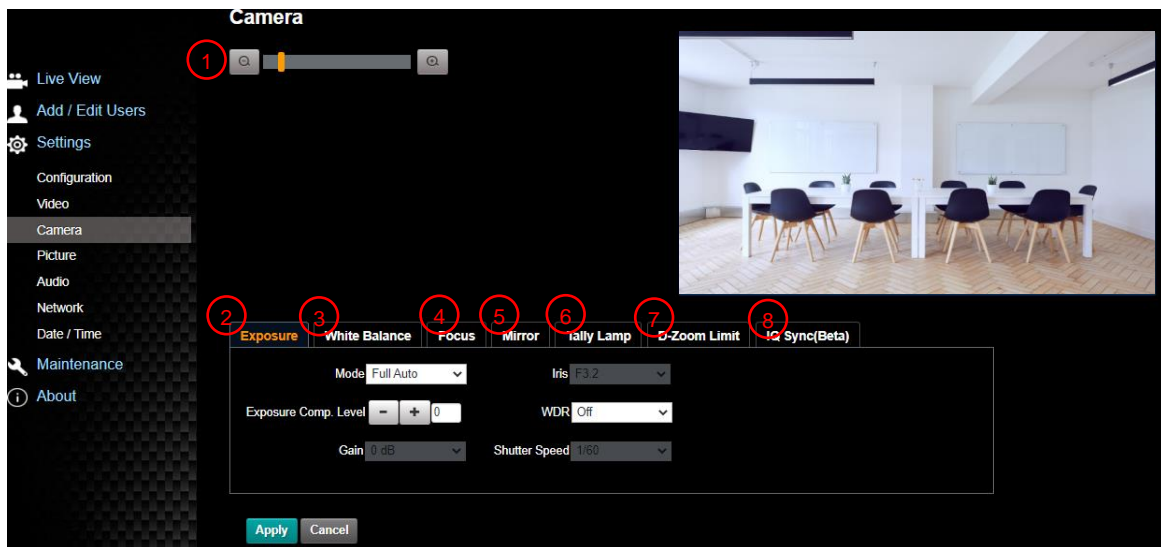
5.3.6 Setting - Camera

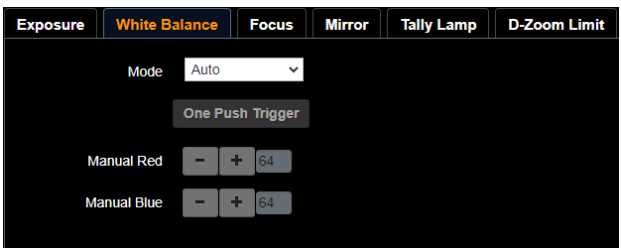

No	Item	Function Descriptions
1	Zoom ratio	Adjust the zoom-in or zoom-out ratio via scroll bar
2	Exposure	 <ul style="list-style-type: none"> ■ Mode: Select exposure mode (Automatic/Shutter Priority/Aperture Priority/ Manual) ■ Exposure Comp. Level: Select exposure compensation level ■ Gain: The gain limit is adjustable when the exposure mode is set to “Manual” ■ Iris: The size of aperture is adjustable when the exposure mode is set to “Manual” or “Aperture Priority” ■ WDR: Set the level of wide dynamic range (WDR) in order to obtain better images ■ Shutter Speed: The shutter speed is adjustable when the exposure mode is set to “Manual” or “Shutter Priority”
3	White Balance	 <ul style="list-style-type: none"> ■ Mode: Select the color temperature mode <ul style="list-style-type: none"> ➢ Auto ➢ Indoor ➢ Outdoor ➢ One Push WB ➢ ATW ➢ Manual ➢ Sodium Lamp ➢ 3000K/ 4300K/ 5000K/ 6500K/ 8000K

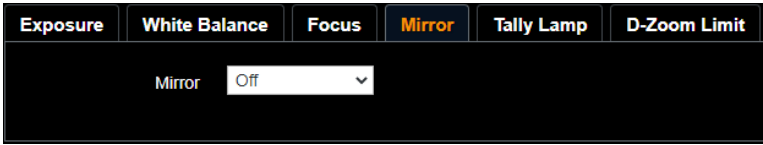
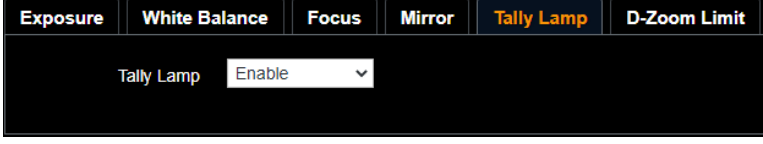
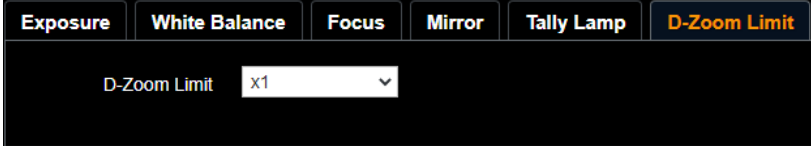
		<ul style="list-style-type: none"> ■ Open Push WB: One push color temperature is adjustable when the white balance mode is set to “One Push WB” ■ Manual Red/Blue: Manually adjust blue/red color temperature
4	Focus	<ul style="list-style-type: none"> ■ Mode: Select manual/automatic focus ■ Focus Range: The focusing range is adjustable when the focus mode is set to “Manual” ■ AF Sensitivity: Set automatic focus sensitivity ■ AF Frame: Set automatic focus range ■ Zoom Tracking: The focus can be set during lens zooming in Manual Focus mode ■ Smart AF: Turn on this function and AF will mainly focus on the face ■ Preset AF: Set whether to perform auto focus after Preset ■ One Push AF: When the manual focus mode is on, click the button to perform one auto focus
5	MIRROR	 <ul style="list-style-type: none"> ■ Mirror: Set the mode at which the image is mirror and flipped <ul style="list-style-type: none"> ➢ Off ➢ Mirror ➢ Flip ➢ Mirror + Flip
6	Tally Lamp	 <ul style="list-style-type: none"> ■ Enable/ Disable Tally Lamp ■ Tally CMMD Mode: Set whether the indicator light is linked with RS232 command <ul style="list-style-type: none"> ➢ General (Not linked): The indicator light switch and mode shall be set separately. <ul style="list-style-type: none"> - When the indicator light is on, and the default mode is off, additional command is required to set the indicator light mode - Setting indicator light mode when the indicator light is off will not trigger the indicator light ➢ Link: <ul style="list-style-type: none"> - When the indicator light is on, the default mode is red light - Setting indicator light mode when the indicator light is off will turn on the indicator light
7	D-Zoom Limit	 <p>Set the D-Zoom Limit, x1 - x12</p>

8	IQ Sync	 <p>Set IQ main synchronized device</p> <p>Available when “Exposure” and “White Balance” is set to “Auto” mode (Currently it’s the beta version. Please refer to Web Page Firmware Update Information for the official version release schedule.)</p>
---	---------	---

5.3.7 Setting - Picture

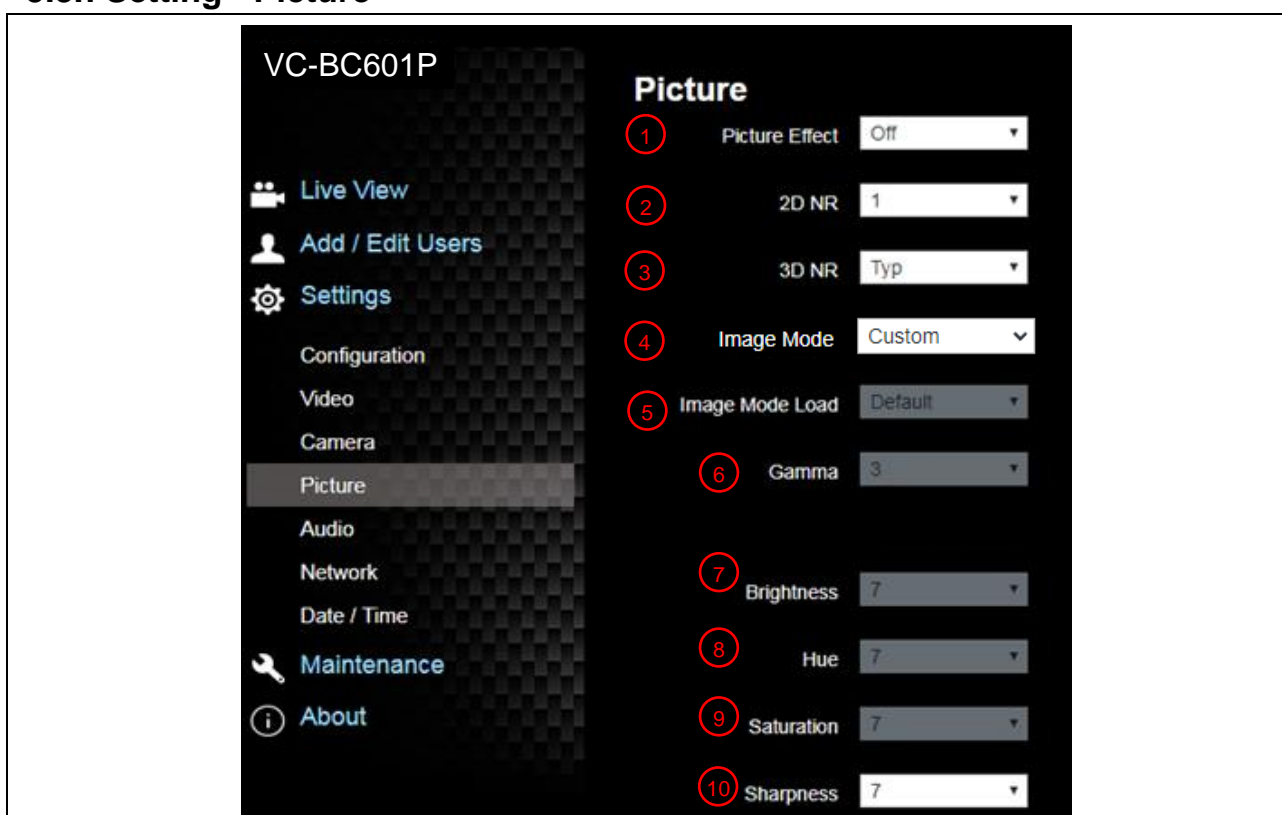

No	Item	Function Descriptions
1	Picture Effect	Set picture effect, Off/Film/Black and White
2	2D NR settings	2D noise reduction settings, selecting from Off/1/2/3
3	3D NR settings	3D noise reduction settings, selecting from Off/Low/Typ/Max
4	Image mode	The user can choose desired image mode: Standard/ LED /Custom
5	Image Mode Load*	When no custom setting is needed, reset the picture parameters back to the factory default by selecting this item
6	Gamma*	Gamma Level adjustment; Adjustable when the image mode is set to Custom
7	Brightness*	Brightness adjustment; Adjustable when the image mode is set to Custom
8	Hue*	Contrast adjustment; Adjustable when the image mode is set to Custom
9	Saturation*	Saturation adjustment; Adjustable when the image mode is set to Custom
10	Sharpness*	Adjust the sharpness of the image

*The setting is enabled only when the image mode is set to Custom

5.3.8 Setting - Audio

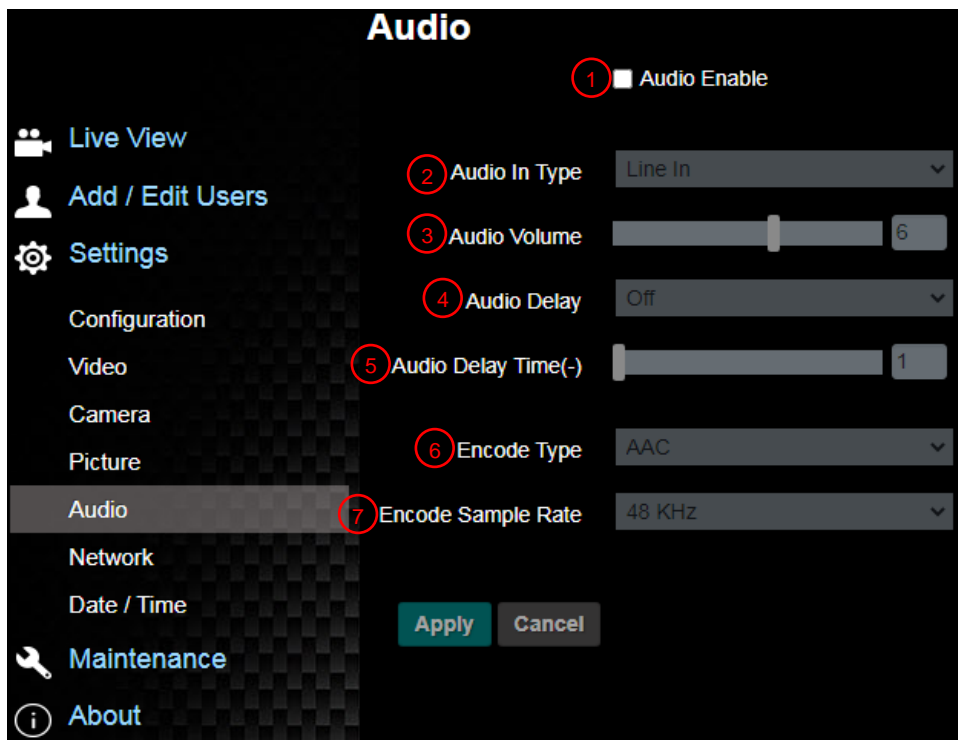

No	Item	Function Descriptions
1	Audio Enable	Turn on/off sound
2	Audio In Type	Set MIC In/Line In
3	Audio Volume	Adjust Volume
4	Audio Delay	Enable / disable Audio Delay
5	Audio Delay Time	Set the audio signal delay time (-1 ~ -500 ms)
6	Encode Type	AAC / G.711
7	Encode sample rate	Set Encode sample rate ➤ 48 KHz (AAC) ➤ 44.1 KHz (AAC) ➤ 16 KHz (G.711) ➤ 8 KHz (G.711)

5.3.9 Setting - Network

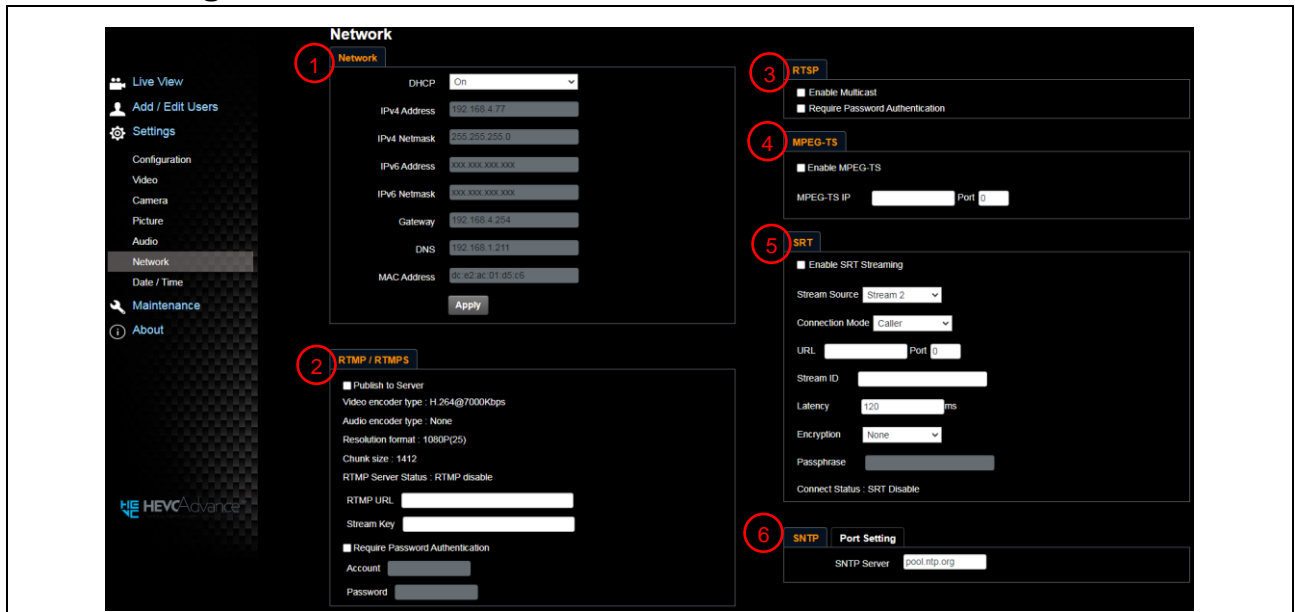

No	Item	Function Descriptions
1	Network	Network setting of camera. Change of setting is available only when DHCP function is closed.
2	RTMP Setting	Copy the RTMP web address provided by the RTMP service platform and paste it to the RTMP connection address to publish the camera images on the RTMP service platform To upload to YouTube for live streaming, the audio function must be turned on first
3	RTSP Setting	Enable/Disable Multicast. It is suggested to enable Multicast when the number of users online watching the live image simultaneously is more than 4
4	MPEG-TS Setting	<div data-bbox="475 1301 1302 1491" data-label="Image"> </div> <p>1. Port must be set in the range above 1024 with a maximum value of 9999</p> <p>The following port has been used by the camera. Setting of the port may not connect correctly</p> <p>8554, 8556, 8557, 8080, 9090, 1935</p>

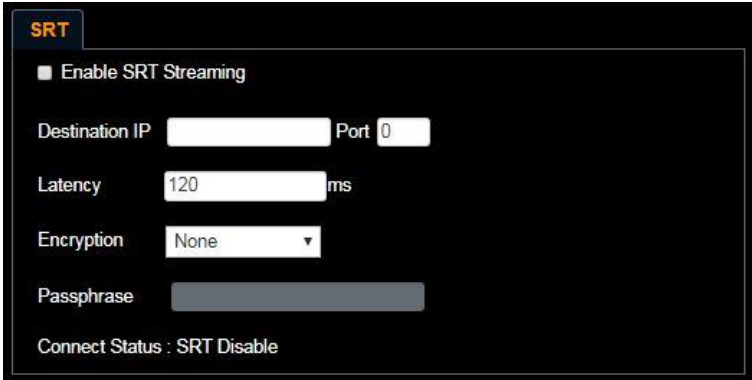
5	SRT Setting	 <p>1. Set the field of SRT and then check the item to open STR streaming After the SRT streaming is opened, it will be connected automatically upon startup</p> <p>2. The port number must be set in the range above 1024 with a maximum value of 9999 The following port has been used by the camera. Setting of the port may not connect correctly 8554, 8556, 8557, 8080,9090,1935</p> <p>3. Delay time is for 20 to 8000 microseconds. The default value is 120 microseconds</p>
6	SNTP/ Port Setting	<ul style="list-style-type: none"> ■ SNTP Setting: Set SNTP Server IP ■ Port Setting: Set HTTP and HTTPS ports. The default values are Port 80 and Port 81 respectively <p><Remark> Change of setting is available only when DHCP function of camera is closed</p>

5.3.10 Setting - Time

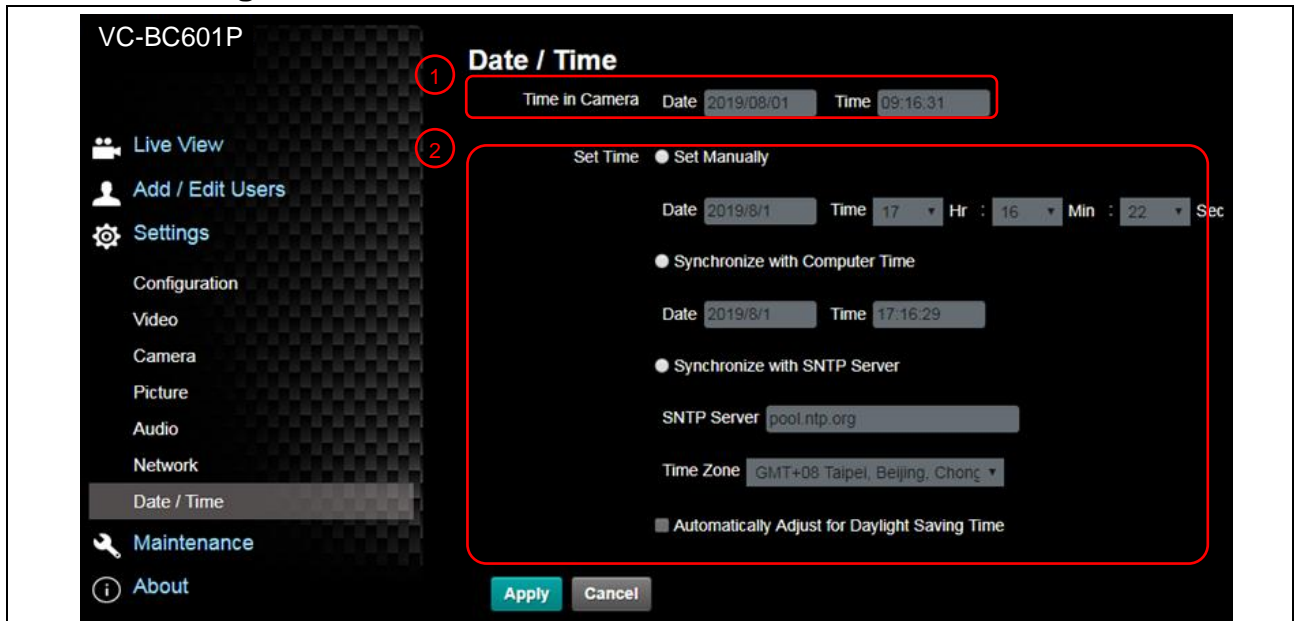

No	Item	Function Descriptions
1	Camera Time	Display the date and time of the camera
2	Set the Time	<ul style="list-style-type: none"> ■ Manual Configuration: Set time manually ■ Synchronize with computer time: Set the camera time according to the computer time ■ Synchronize with SNTP server: Set the camera time synchronously with the SNTP server <p><Remark> SNTP server address: Please change in network setting</p>

5.3.11 Setting - Maintenance - Upgrading Firmware

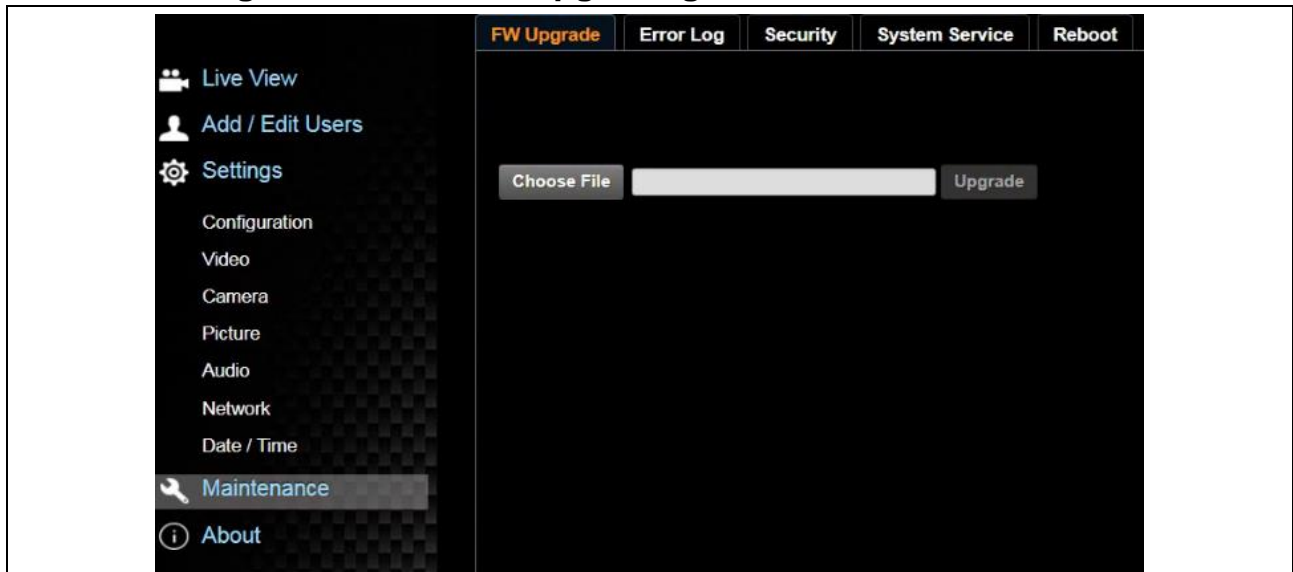

No	Item	Function Descriptions
1	Firmware Update	The camera firmware may be upgraded via web page. For the upgrade method, please download the FW upgrade manual from Lumens official website

5.3.12 Setting - Maintenance - Error Log

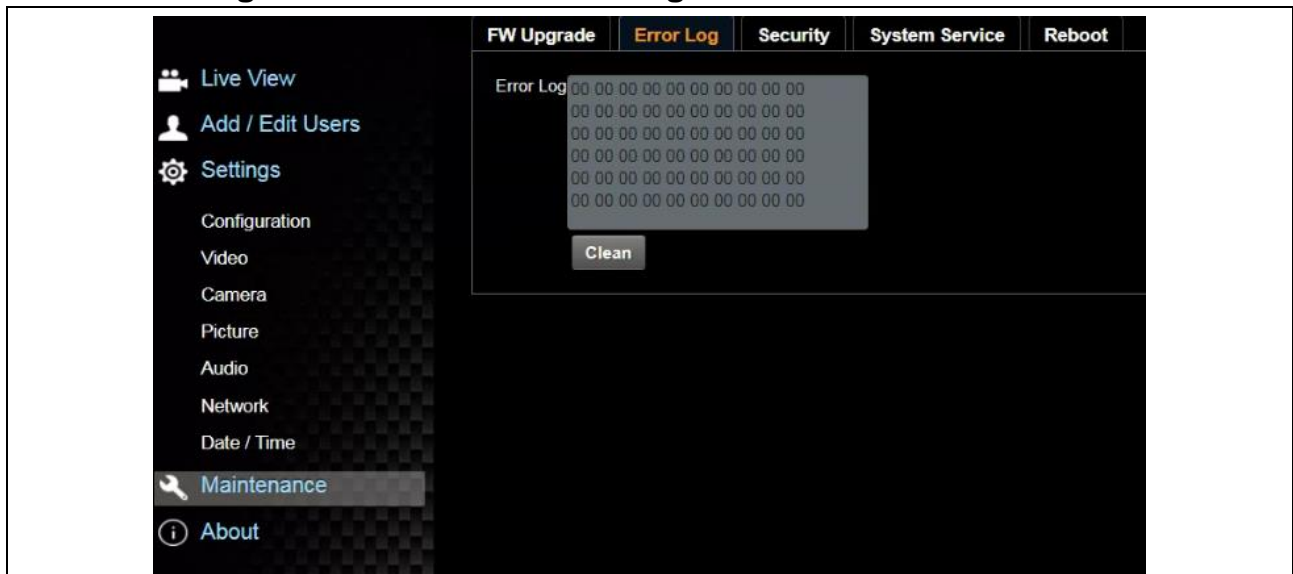

No	Item	Function Descriptions
1	Error Logs	If the camera encounters errors, an error code log will be established <Remark> If an error code appears, the user may try to clear and confirm if the error will repeat itself

5.3.13 Setting - Maintenance - Security

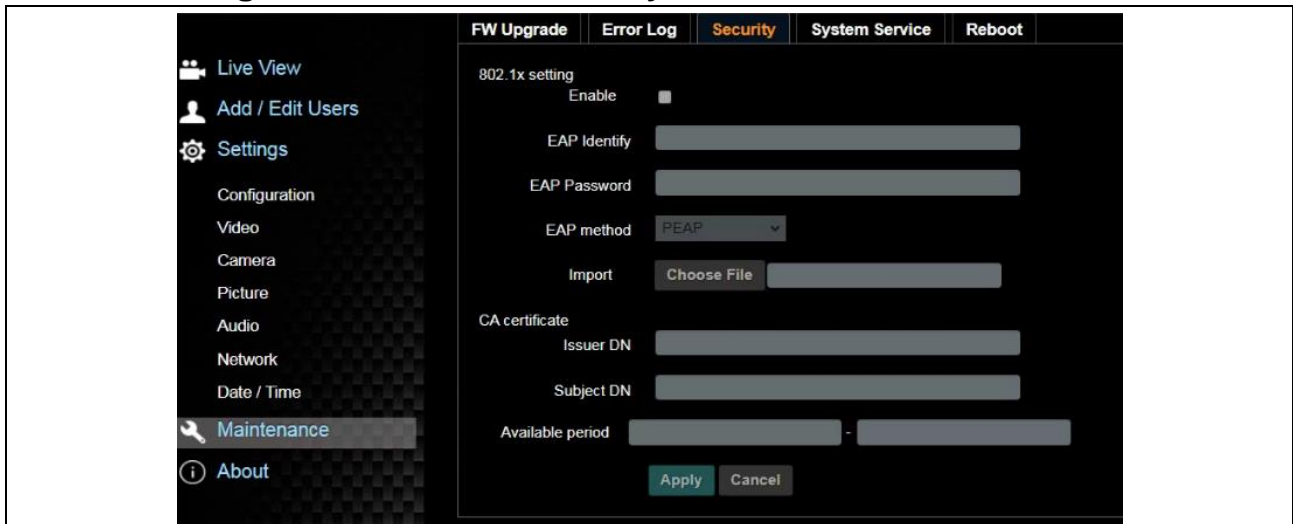

No	Item	Function Descriptions
1	802.1x Setting	Enable/disable 802.1x protocol, and configure settings when enabled <Remark> The router must support 802.1x protocol to enable this feature

5.3.14 Setting - Maintenance - System Service

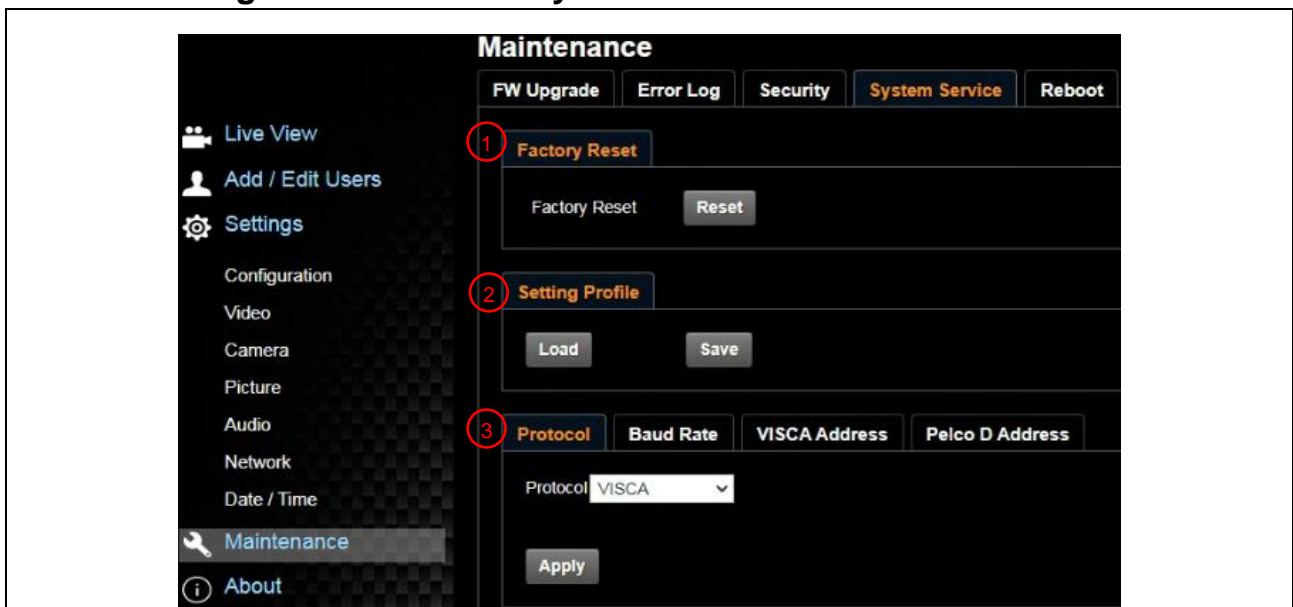

No	Item	Function Descriptions
1	Factory Reset	Select the reset button to resume the factory default setting as the web page setting
2	Setting Profile	The web page setting parameters can be exported from the computer and imported/applied to another camera
3	Communication protocol related settings	Communication protocol related settings for the use of connecting RS-232/ RS-422 communication

5.3.15 Setting - Maintenance - Reboot

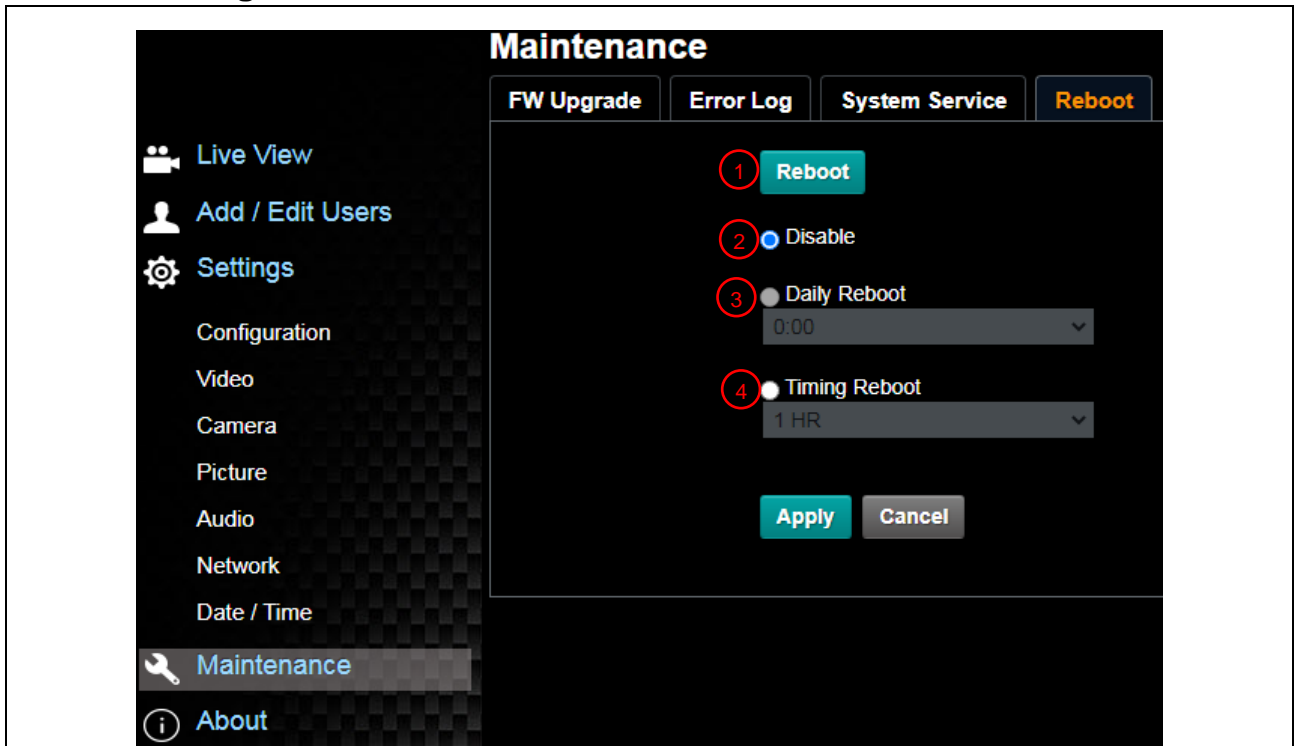

No	Item	Function Descriptions
1	Reboot	Reboot immediately
2	Disable	Disable the reboot settings
3	Daily Reboot	Set the daily reboot time <Remark> Please go to Settings - Time to complete the SNTP server synchronization to set daily reboot
4	Timing Reboot	Set the timing reboot time

5.3.16 About

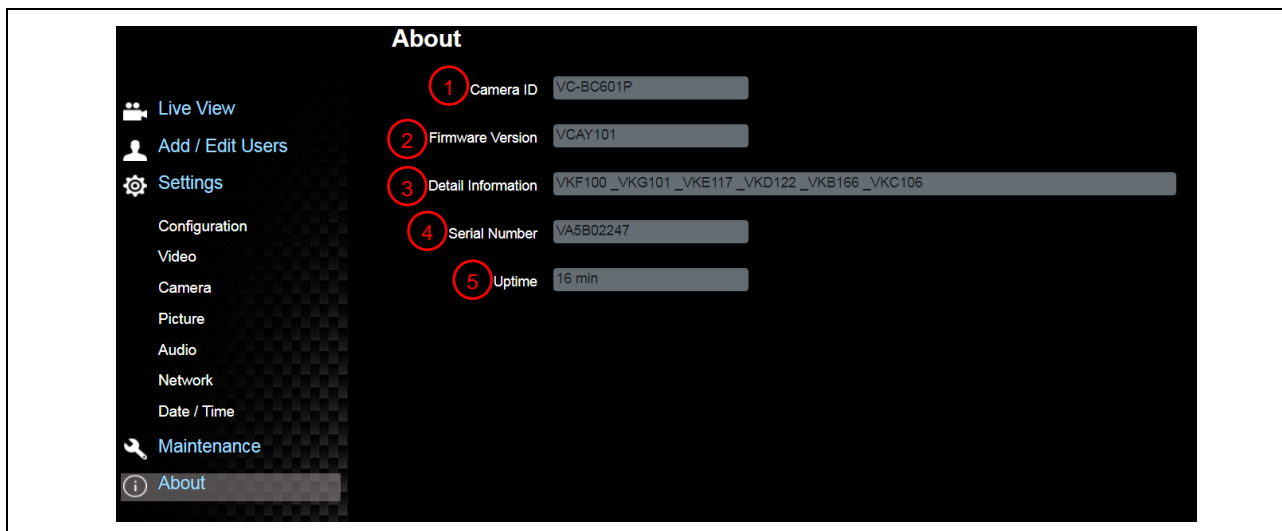

No	Item	Function Descriptions
1	Camera ID	Display the camera name
2	Firmware Version	Display the firmware version of the camera
3	Detail Information	Display firmware version-related information
4	Serial No.	Display the camera serial No.
5	Uptime	Displaying the running time of the camera (the timing of standby continues; the time will be reset when the camera is rebooted or turned off)

Chapter 6 Troubleshooting

This chapter describes problems you may encounter while using VC-BC601P. If you have questions, please refer to related chapters and follow all the suggested solutions. If the problem still occurred, please contact your distributor or the service center.

No.	Problems	Solutions
1.	Boot without power signal	<ol style="list-style-type: none">1. Make sure you have plugged in the power cord.2. When using a PoE connection, ensure that the power supply supports IEEE 802.3af hubs
2.	There is no image output from VC-BC601P	<ol style="list-style-type: none">1. Check the power supply or PoE supply functions.2. Make sure the display supports the output resolution; in general, the resolution is 1080p60/720p60.3. Replace the cables and make sure they are not faulty.
3.	RS-232 cannot be controlled	<ol style="list-style-type: none">1. Confirm the connection is correct (RS-232 Input/Output)2. Please make sure the Baud rate setting is the same as the control equipment
4.	The ONVIF software cannot find the machine	Please go to Setting - Video - Camera Location in the webpage and make sure that the ID is only made up of English letters or numbers. The Onvif software cannot find the machine if you use special characters and space.
5.	Tally lamp is not working when applying RS232 setting	Please go to Setting - Camera - Tally Lamp in the webpage to check if the function is on.